



INSTRUCTIONS

IMPORTANT SAFEGUARDS

When using electrical equipment, basic safety precautions should always be followed including the following:

- 1. READ AND FOLLOW ALL SAFETY INSTRUCTIONS**
2. Disconnect power before performing work on electrical equipment.
3. Do not let power cords touch hot surfaces and do not mount near gas or electric heaters.
4. Use caution when servicing batteries. Battery acid can cause burns to skin and eyes. If acid is spilled on skin or eyes, flush with fresh water and contact a physician immediately.
5. Equipment should be mounted in locations and at heights where unauthorized personnel will not readily subject it to tampering.
6. The use of accessory equipment not recommended by BeLuce Canada Inc., may cause an unsafe condition, and will void the unit's warranty.
7. Do not use this equipment for other than its intended purpose.
8. Servicing of this equipment should be performed by qualified service personnel.
- 9. SAVE THESE INSTRUCTIONS!**

INSTALLATION

NOTE: FIXTURE ORIENTATION IS IMPORTANT FOR LIGHT DISTRIBUTION - SEE PAGE 3

Surface Mounting with Conduit Entry:

1. Extend unswitched DC supply of 12 or 24 volts from a conduit (supplied by others) installed in accordance with all applicable codes and standards. This circuit should NOT be energized/live at this time.
2. Open the unit by removing (4) cover mounting screws. (Figure 1)
3. Knockout (2) mounting holes in back of back box, then knockout side entry hole to add hazardous conduit bushing. Peel backing of gasket and stick to back of back box. (Figure 1)

Alternate method using straps, see figures 6 and 7.

Knockout side entry hole to add waterproof strain relief (by others). Secure both straps with 2 screws and place the back box to mounting surface with 4 screws (by others). Skip to #5

4. Secure back box to mounting surface with (2) screws (not supplied).
5. Make proper wiring connections. **NOTE! Positive and negative polarity is critical and will damage unit.**
Yellow lead wire (+). Purple lead wire (-).
6. Route wires and secure in place.
7. Replace cover. Note cover orientation.
8. Light distribution can be changed by using a different lens. See page 3 and Figures 4 and 5.

Junction Box Mounting:

1. Extend unswitched DC supply of 12 or 24 volts to a junction box (supplied by others) installed in accordance with all applicable codes and standards. Leave at least 8 inches of slack wire.
2. Open the unit by removing (4) cover mounting screws. (Figure 1)
3. Knockout (2) mounting holes and (1) entry hole in back of back box.
4. Peel backing of gasket and stick to back of back box. (Figure 1)
5. Feed wires through entry hole and secure back box to junction box.
6. Make proper wiring connections. **NOTE! Positive and negative polarity is critical and will damage unit.**
Yellow lead wire (+). Purple lead wire (-).
7. Route wires and secure in place.
8. Replace cover. Note cover orientation.
9. Light distribution can be changed by using a different lens. See page 3 and Figures 3, 4 and 5.

Figure 1

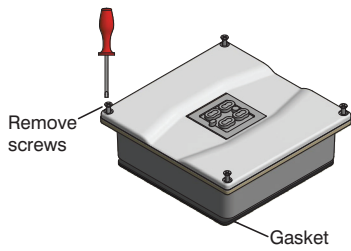

Figure 2

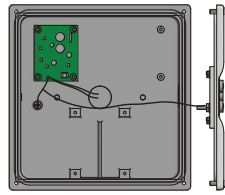

Figure 3

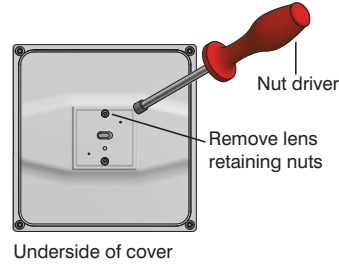

Figure 4

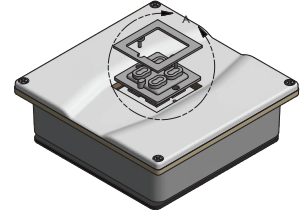

Figure 5

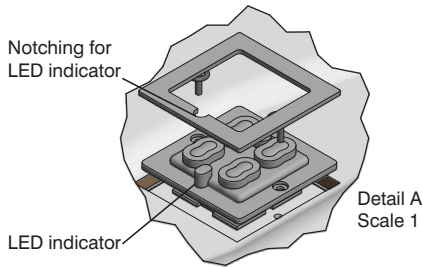

Figure 6

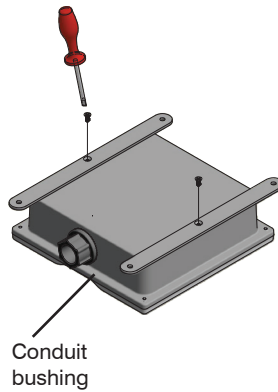
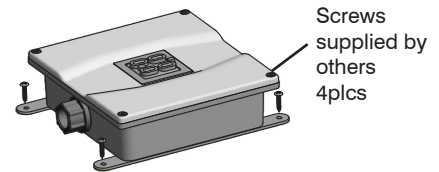

Figure 7



MAINTENANCE

1. Clean lenses on a regular basis.

NOTE: The servicing of any parts should be performed by qualified personnel only. The use of replacement parts not furnished by BeLuce Canada Inc., may cause equipment failure and will void the warranty.

SAVE THESE INSTRUCTIONS

CEILING MOUNT

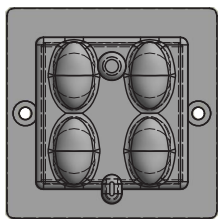

CEILING LENS
RECTANGULAR
LIGHT DISTRIBUTION

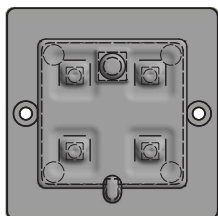

WALL MOUNT LENS

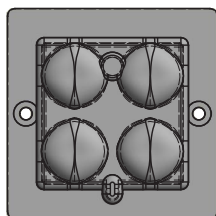

CEILING LENS
SQUARE
LIGHT DISTRIBUTION

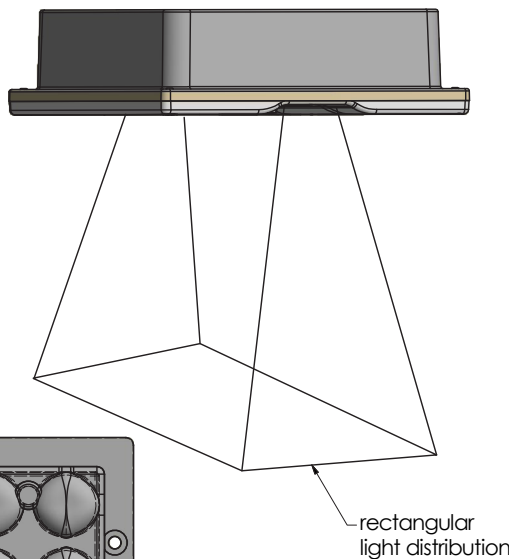

Max. mounting height is 14.5 ft to get an average illuminance above 1 fc, based on 3x3 ft room 80/50/20 reflectance.

WALL MOUNT

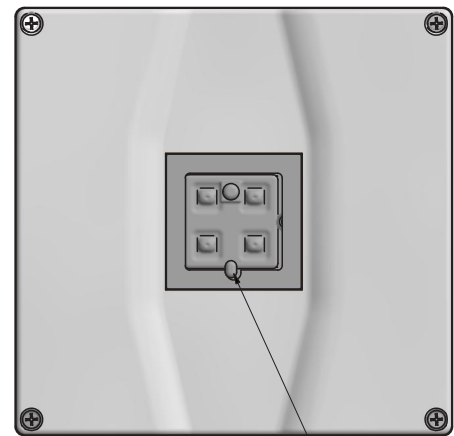

LED INDICATOR
FACING TO THE FLOOR

